

## Naturally wood.



ACTO 2 the first and only modular system that "weds" both worlds of custom and modular displays. The combination of tinted, varnished wood for its stateliness, anodized aluminium for its lightness and laminate for its ease of maintenance, achieve this harmony.

### ■ CONNECTORS ACTO 2

Made of anodized aluminium, the single or double ring connectors allow for multidirectional assembly and stacking without the use of tools. Stationary feet, also made of aluminium, are fit with adjustable screw.

### ■ PANELS

Two vertical frame posts, made of exotic wood are tinted and varnished, highlighting the laminate decor. Available in your choice of colors and motifs. Glued on honeycomb web filling, they are available in all 36 sizes.

### ■ FRAMES

Made of tinted and varnished exotic wood, they can be assembled with most structural fillings, identical to the ACTO1 system. Available in most sizes of the grid

### ■ ACCESSORIES

A whole range of accessories also in the ACTO spirit.

- *Multi-directional*
- *Multi-panels*
- *No tools*

# CONNECTORS



*Adjustable foot*



*Double connector*



*Single connector*



*Special connector for doors*

- Made of anodized aluminium, the foot, the single or double ring connectors allow for multi-directional assembly and stacking without the use of tools.
- Single is used for the top.
- Double is used between horizontal runs of panels and frames.
- The foot allows for level adjustments, with its adjustable screw.

Material: Natural anodized Aluminium.

---

Single 01  
 Double 02  
 Foot 03  
 Special " doors" 04

# ACTO2 WOOD GRID

	237,5 mm	340 mm	485 mm	690 mm	730 mm	980 mm	
A							245 mm
B							490 mm
C							735 mm
D							980 mm
F							1475 mm
H							1965 mm
	1	2	3	4	5	6	

36 standard sizes are available to meet most of your needs by height and width: 6 heights and 6 widths, making a geometrical grid, based on the metric system from connector's axis to axis.

## ■ Panels.

Two vertical frame posts, made of exotic wood are tinted and varnished, highlighting the laminate décor.

Available in your choice of colors and motifs. (Print Abet Laminati Colors or Legni range;

Website : ([www.abet-laminati.it](http://www.abet-laminati.it))

Glued on a honeycomb web filling, they are available in all 36 sizes.

## ■ Frames.

Made of tinted and varnished exotic wood and easily dismantled, they can be assembly with most of structural fillings: PVC, metal peg board sheet, micro-perforated aluminium sheet, mettalic mesh, safety glass, Plexiglas, laminate or glass sliding or hinged doors, etc...

Depending on the type of structural filling, they are available in specific sizes of the grid.

### **The grid:**

Heights are lettered from A to H and widths numbered from 1 to 6, to simplify the request of sizes.

### **Example :**

Panel 1965x 730 ( connector's axis to axis)

Theoretical size is 1980 x750

REF H5.

# THE STANDARD PANELS

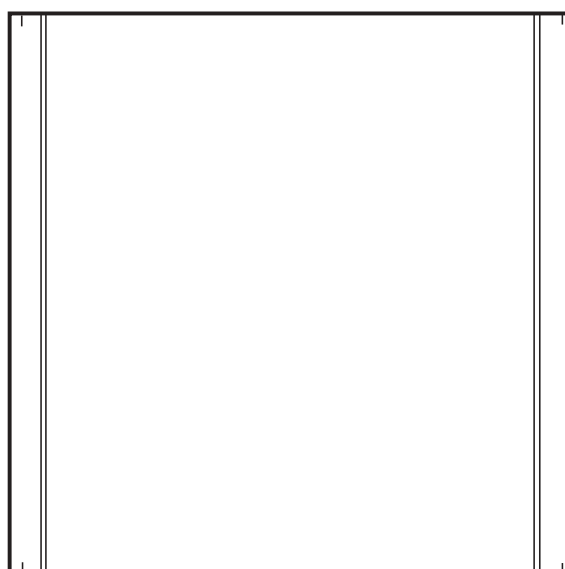
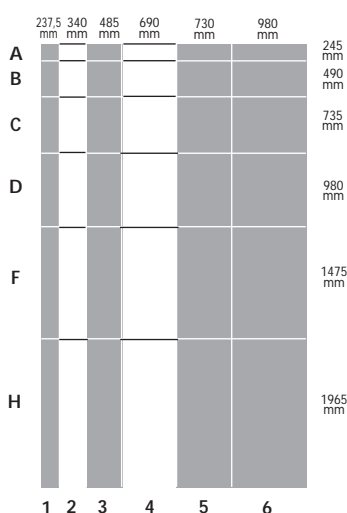

Sizes. :

A1	A3	A5	A6
B1	B3	B5	B6
C1	C3	C5	C6
D1	D3	D5	D6
F1	F3	F5	F6
H1	H3	H5	H6

Panels available in all standard sizes.  
 Wood frame integrated, vertical exotic posts.  
 Honeycomb interior  
 Colored or Wood Laminate 9/10° both sides.  
 Thickness 24 m/m  
 Average weight per square meter: 4 kgs  
**French Flame retardant Certification M1.**

**Available on request :**

Wood laminate Print Legni range  
 or Colors laminate.

[www.abet-laminati.it](http://www.abet-laminati.it)

**Available on request :**

3 different tinted varnishes :

Clear: beech ,

medium : mahogany or dark: oak

# THE HYPOTENUSE PANELS

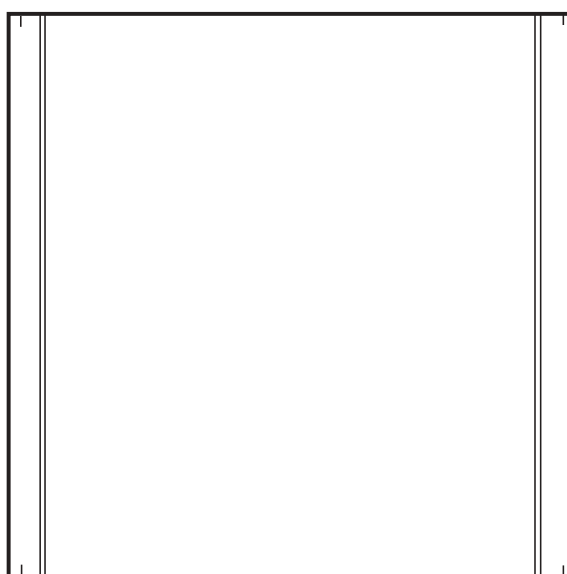
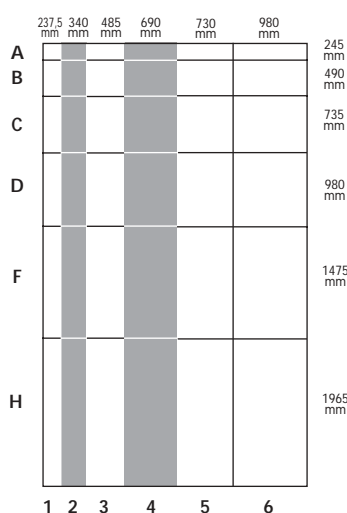

Available sizes in the ACTO grid :

A2 A4  
B2 B4  
C2 C4  
D2 D4  
F2 F4  
H2 H4

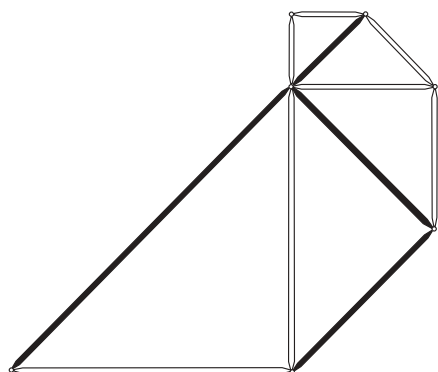

The hypotenuse panels, together with standards panels, allow for the construction of right-angles triangles as shown in diagram.

Wood frame integrated, vertical exotic posts.  
Honeycomb interior  
Colored or Wood Laminate 9/10° both sides.  
Thickness 24 m/m  
Average weight per square meter: 4 kgs  
**French Flame retardant Certification M1.**

**Available on request :**

Wood laminate Print Legni range  
or Colors laminate ([www.abet-laminati.it](http://www.abet-laminati.it))

**Available on request :**

3 different tinted varnishes :  
Clear: beech ,  
medium : mahogany or dark: oak

# THE SHELF SUPPORT PANELS

	237.5 mm	340 mm	485 mm	690 mm	730 mm	980 mm	
A							245 mm
B							490 mm
C							735 mm
D							980 mm
F							1475 mm
H							1965 mm
	1	2	3	4	5	6	

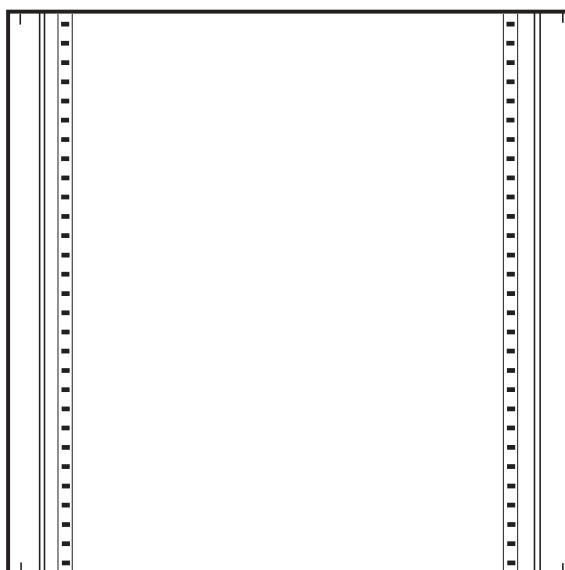

Available sizes in the ACTO grid :

B2	B3	B4	B5
C2	C3	C4	C5
D2	D3	D4	D5
F2	F3	F4	F5

Wood frame integrated, vertical exotic posts fitted with bracket-bars.

Honeycomb interior.

Colored or Wood Laminate 9/10° both sides.

Thickness 24 m/m

Average weight per square meter: 4,2 kgs

French Flame retardant Certification M1.

The shelf support panels can be fitted on the uprights with removable shelf support accessories, allowing for the assembly of counters, shelving wood or glass systems...

Available on request :

Wood laminate Print Legni range

or Colors laminate ([www.abet-laminati.it](http://www.abet-laminati.it))

Available on request :

3 different tinted varnishes :

Clear: beech , medium : mahogany or dark: oak

# EMPTY FRAMES

	237,5 mm	340 mm	485 mm	690 mm	730 mm	980 mm	
A							245 mm
B							490 mm
C							735 mm
D							980 mm
F							1475 mm
H							1965 mm
	1	2	3	4	5	6	

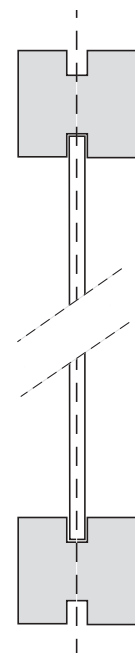
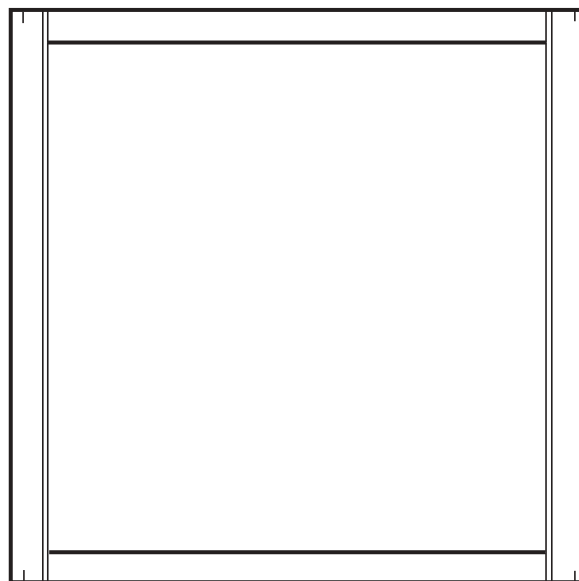

Sizes :

*Frames available in all standard sizes*

Exotic tinted varnished frame.

Easily disassembled.

The ACTO2 frames can be fitted with any rigid material with a thickness of 4 m/m to the max, allowing for a large number of fillings.

As standard products, ACTO offers a serie of materials already fitted in the frames.

**Frame varnish colors:**

Clear: beech , medium : mahogany or dark: oak

# THE FRAMES WITH PEG-BOARD FILLING

	237.5 mm	340 mm	485 mm	690 mm	730 mm	980 mm	
A							245 mm
B							490 mm
C							735 mm
D							980 mm
F							1475 mm
H							1965 mm
	1	2	3	4	5	6	

Sizes :

Frames available in all standard sizes

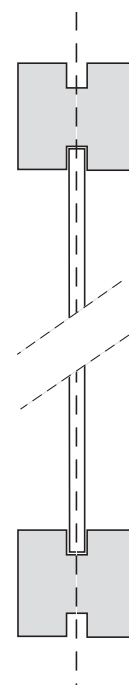
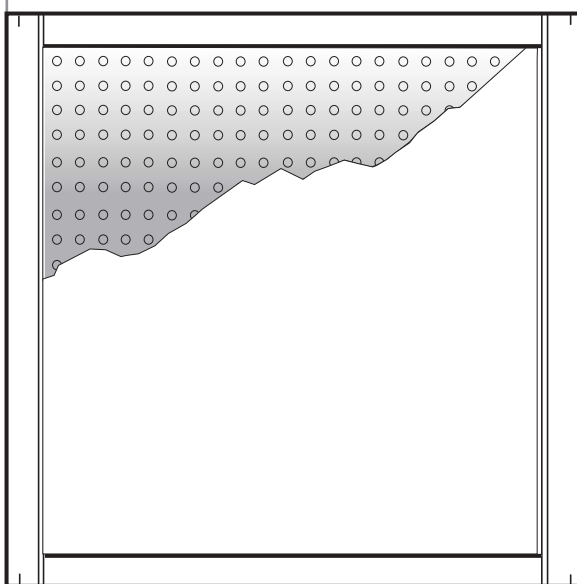

Exotic tinted varnished frame.

Easily disassembled.

Aluminium sheet, coated with Alu metal Epoxy,

Ø 5 m/m holes, 25 m/m between axis;

The peg-board frames are compatible with most commercial peg-board accessories.

Frame varnish colors:

Clear: beech , medium : mahogany or dark: oak

# THE FRAMES WITH MICRO-PERFORATED FILLING

	237.5 mm	340 mm	485 mm	690 mm	730 mm	980 mm	
A							245 mm
B							490 mm
C							735 mm
D							980 mm
F							1475 mm
H							1965 mm
	1	2	3	4	5	6	

Sizes :

Frames available in all standard sizes

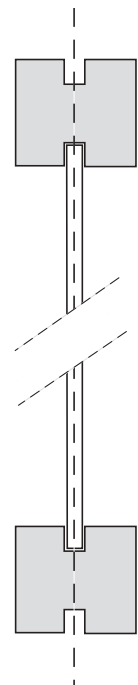
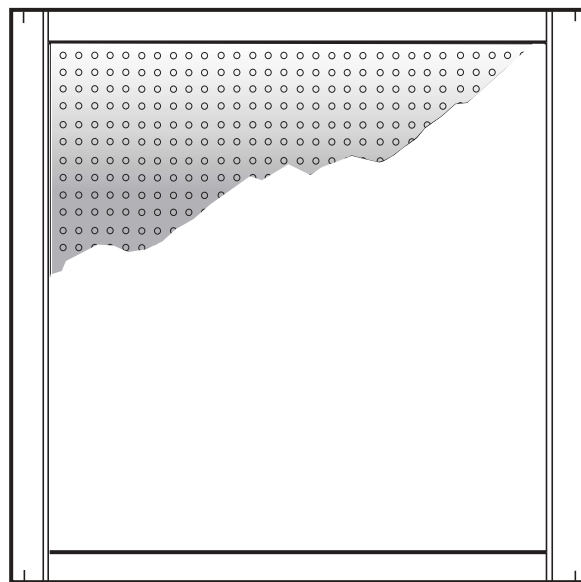

Exotic tinted varnished frame.  
Easily disassembled.  
Micro-perforated aluminium coated with Alu metal Epoxy.

Standard drilling R2T3.5, R3T5, R5T8, C5U7.5x7.5  
Other drilling sizes on request.

**Frame varnish colors:**

Clear: beech , medium : mahogany or dark: oak

# THE FRAMES WITH WIRE MESH FILLING

	237,5 mm	340 mm	485 mm	690 mm	730 mm	980 mm	
A							245 mm
B							490 mm
C							735 mm
D							980 mm
F							1475 mm
H							1965 mm
	1	2	3	4	5	6	

Sizes :

Frames available in all standard sizes

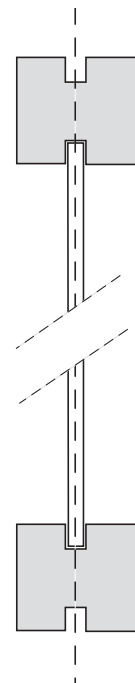
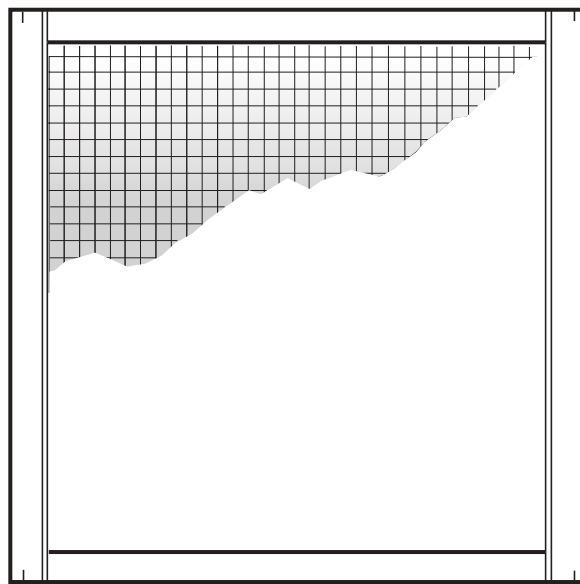

Exotic tinted varnished frame.

Easily disassembled.

50 X 50 m/m wire mesh, Ø 4m/m, Alu metal Epoxy.

Wire mesh frames can fit most standard fashion or sportswear accessories.

Frame varnish colors:

Clear: beech , medium : mahogany or dark: oak

# THE GLASS FRAMES

	237,5 mm	340 mm	485 mm	690 mm	730 mm	980 mm	
A							245 mm
B							490 mm
C							735 mm
D							980 mm
F							1475 mm
H							1965 mm
	1	2	3	4	5	6	

Sizes :

Frames available in all standard sizes

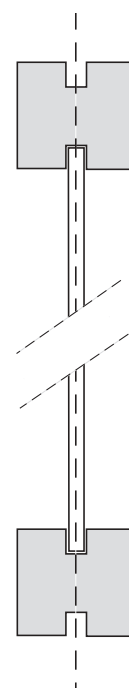
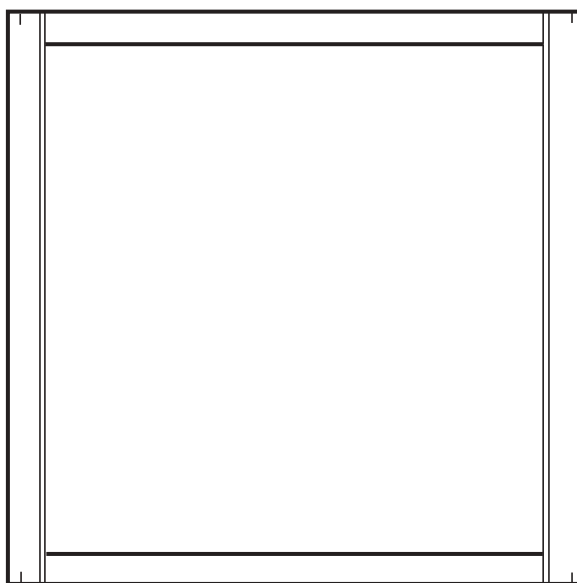

Exotic tinted varnished frame.  
Easily disassembled.  
Clear safety glass, 4 m/m thick.  
The ACTO glass frames allow for the construction of showcases and transparent dividing walls. Glass sliding doors are also available.

Frame varnish colors:

Clear: beech , medium : mahogany or dark: oak

# THE PLEXIGLAS or PVC FRAMES

	237.5 mm	340 mm	485 mm	690 mm	730 mm	980 mm	
A							245 mm
B							490 mm
C							735 mm
D							980 mm
F							1475 mm
H							1965 mm
	1	2	3	4	5	6	

Sizes :

Frames available in all standard sizes

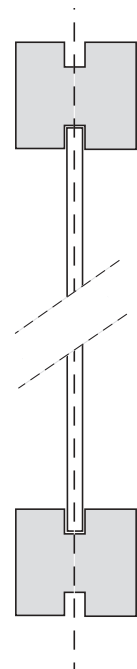
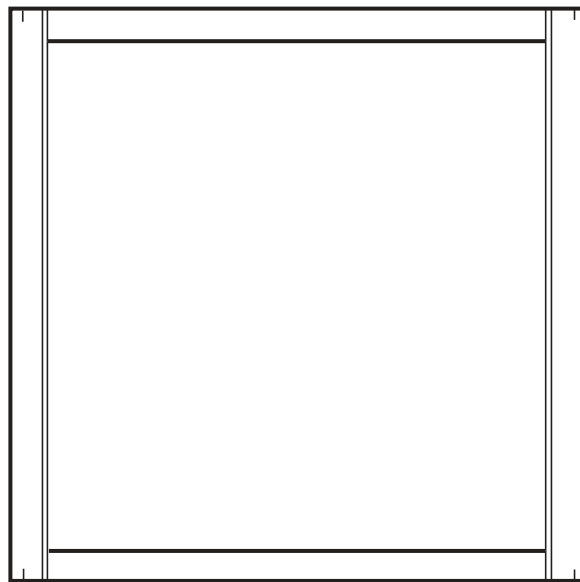

Exotic tinted varnished frame.  
Easily disassembled.  
Clear or smoked Plexiglas, 3 m/m,  
or expanded P.V.C. 3 m/m thick  
The ACTO P.V.C. frames allow for the mounting of graphics;  
which can be easily changed.

**Frame varnish colors:**

Clear: beech , medium : mahogany or dark: oak

**Material code:**

Clear Plexi 50

Smoked Plexi 51

Double plexi clear/ diffusing 52

Light P.V.C.53

# THE SLIDING DOORS

	237.5 mm	340 mm	485 mm	690 mm	730 mm	980 mm	
A							245 mm
B							490 mm
C							735 mm
D							980 mm
F							1475 mm
H							1965 mm
	1	2	3	4	5	6	

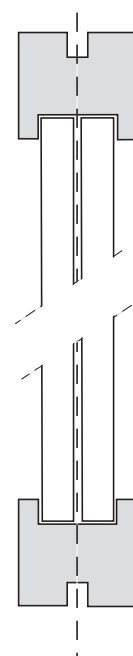
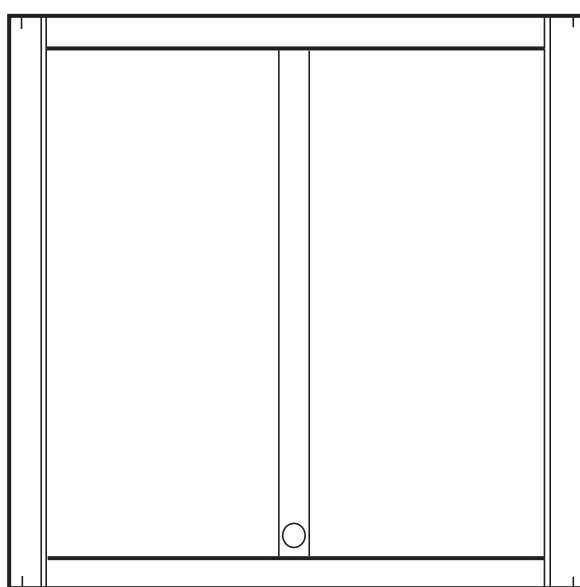

Available sizes :

A3	A4	A5	A6
B3	B4	B5	B6
C3	C4	C5	C6
D3	D4	D5	D6
F3	F4	F5	F6

Exotic tinted varnished frame.

Consisting of 2 doors with safety glass 4m/m, solid laminate , or clear Plexiglas.

Lock with keys.

The ACTO frames with sliding doors allow for storage in showcases and counters.

**Frame varnish colors:**

Clear: beech , medium : mahogany or dark: oak

**Available on request :**

Wood laminate Print Legni range  
or Colors laminate ([www.abet-laminati.it](http://www.abet-laminati.it))

**Material code:**

Safety Glass 40  
Clear Plexi 50

# THE HINGED DOORS

	237,5 mm	340 mm	485 mm	690 mm	730 mm	980 mm	
A							245 mm
B							490 mm
C							735 mm
D							980 mm
F							1475 mm
H							1965 mm
	1	2	3	4	5	6	

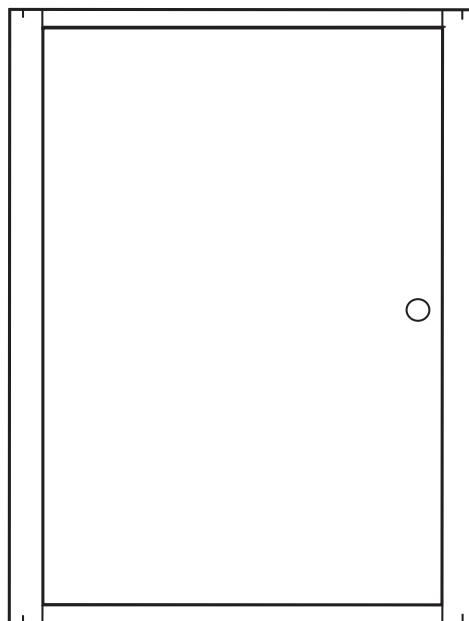

Exotic tinted varnished frame.

Laminate hinged door;  
Lock with keys.

Available on request :  
Wood laminate Print  
Legni range  
or Colors laminate  
[www.abet-laminati.it](http://www.abet-laminati.it)

Available sizes :

C3 C4 C5 C6  
D3 D4 D5 D6  
F3 F4 F5 F6

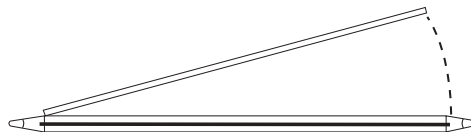

# THE DOORS

	237,5 mm	340 mm	485 mm	690 mm	730 mm	980 mm	
A							245 mm
B							490 mm
H							1965 mm
	1	2	3	4	5	6	

Available sizes  
 H5 1970x730  
 H6 1970 x 980

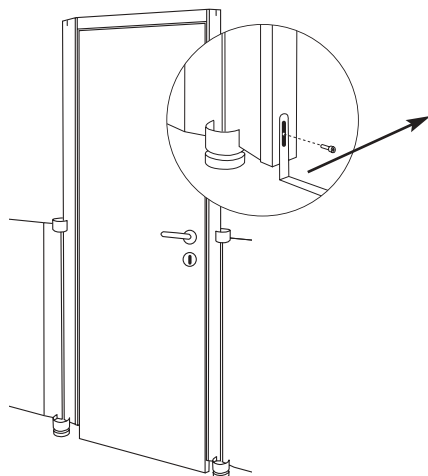
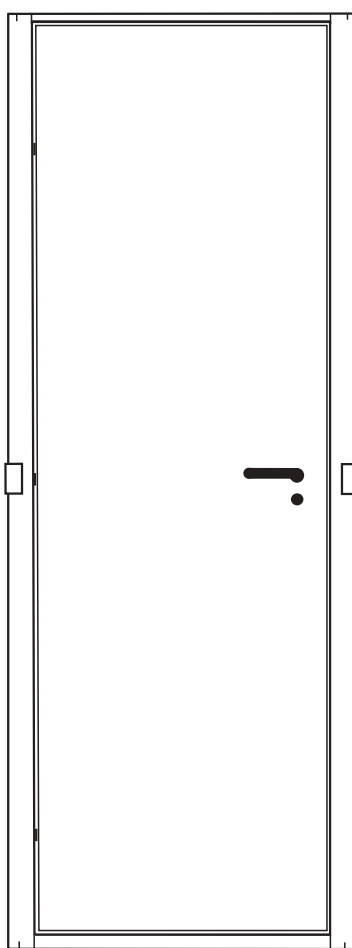
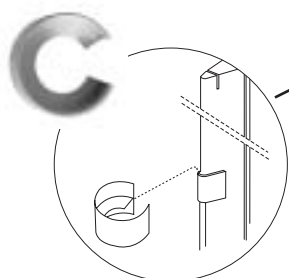

Hinges left side 3610



Hinges right side 3510

Reinforced Exotic tinted  
 varnished frame.  
 Light-weight hollow door.  
 Laminate both sides.  
 White or grey handles  
 Locks with keys.  
 Opening direction:  
 Hinges right side 3510  
 Hinges left side 3610

**Frame varnish colors:**  
 Clear: beech , medium :  
 mahogany or dark: oak

**Available on request :**  
 Wood laminate Print Legni  
 range  
 or Colors laminate  
[www.abet-laminati.it](http://www.abet-laminati.it)

# TOPS, CEILING AND SHELVES

1	2	3	4	5	6

**Available sizes :**

Squares, rectangles, isosceles and equilateral triangles.

**Square :**

11 22 33 44 55 66

**Rectangle :**

12 13 14 15 16  
23 24 25 26  
34 35 36  
45 46  
56

**Right angled triangle :**

12 23 34 46

**Equilateral triangle :**

22 33 44 55 66

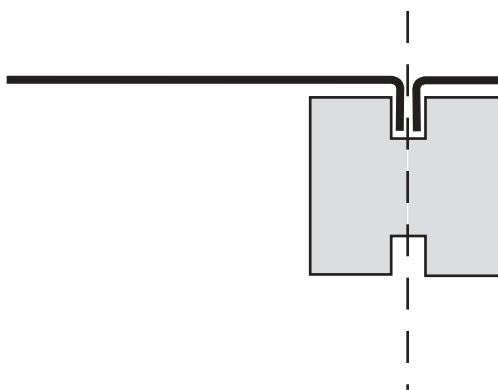

■ **Tops**

Aluminium sheet 12/10° coated with Alu metal Epoxy.

90° fold allowing for insertion into the upper grooves of frames and panels

■ **Ceilings for showcases.**

Same as for tops, but having an opening of 70m/m for fitting lighting.

■ **Spotlights available on request.**

■ **On request:**

- Tops safety glass 6 m/m
- Strong laminate 16 m/m thick.

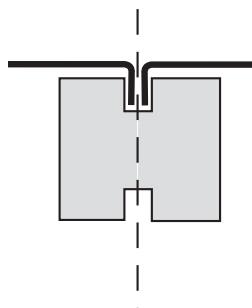

Tops and ceilings can be setted side by side

N.B For display of heavy items, tops and shelves are available in laminate, thickness 16 m/m.

# THE TRUSSES



Available sizes :

A2 A3 A4 A5 A6  
 A7 (1380 mm)  
 A8 (1980 mm)

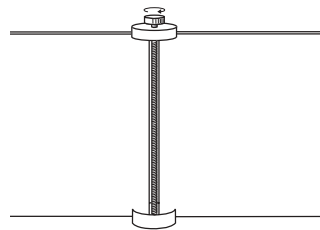

Exotic tinted varnished frame.  
 Aluminium filling with holes  
 Ø 120 m/m, coated Alu metal Epoxy

N.B. Exist in length 1390 m/m  
 (size A7) and 1980 m/m (size A8)

Frame varnish colors:

Clear: beech ,  
 medium : mahogany or dark: oak

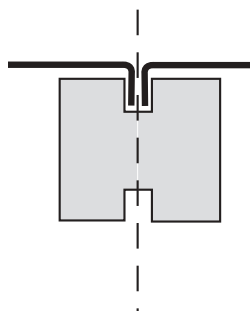
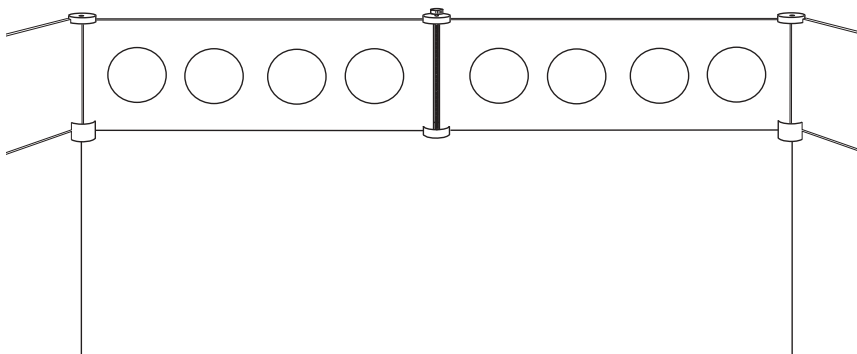

N.B. ACTO panels with a height of A ( 245 m/m) can be used as trusses or girders.  
 Trusses allow for every kind of ceilings, which can be set up side by side (Ocf diagram)

# ACCESSORIES

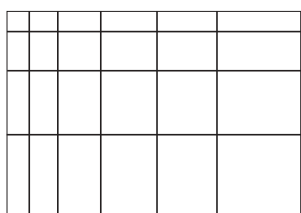

*All the accessories can be fitted into the upper groove of the ACTO panels and frames.*



■ Shelves:  
 300 x 450 for width 3  
 300 x 655 for width 4  
 300 x 695 for width 5  
 300 x 945 for width 6



■ Literature shelf:  
 Aluminium Alu metal  
 Epoxy  
 Sizes:  
 HT 310 Width 220  
 HT 310 Width 440

■ Shelves/ Literature shelf/ Coat bag hook/ Clip/ Top shoot.

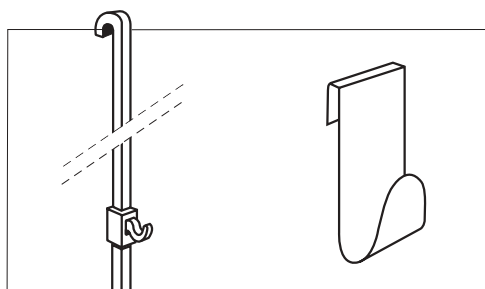

■ Coat/bag hook:  
 Adjustable hanger with hook;

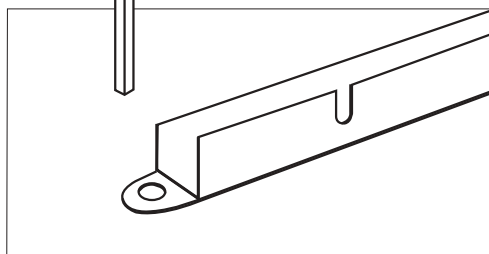

■ On Request:  
 Top gutters for electrical cables, alu metal Epoxy.  
 Width from 2 to 7  
 ( 340 m/m to 1390 m/m)

# LIGHTING

■ ACTO. 220 VOLTS.

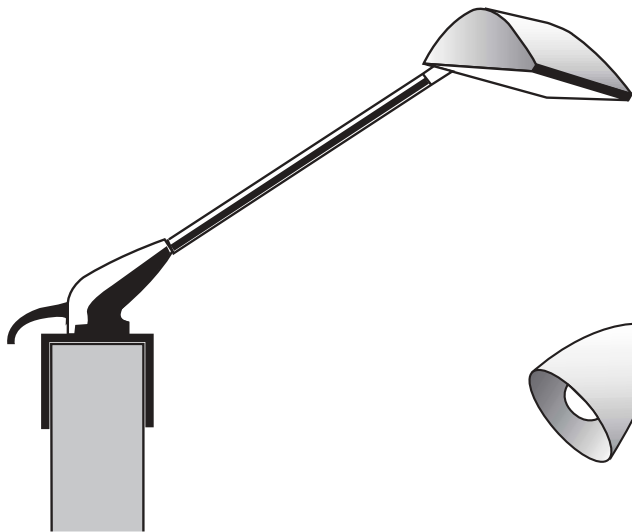

SPOT LITACTO 02 grey  
220 volts, 150 watts Halogen.

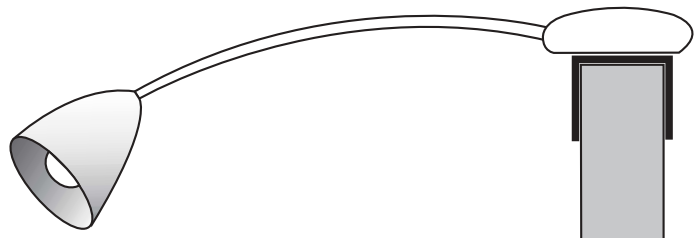

SPOT LINEX 03 grey  
220 volts, 75 watts Halogen.

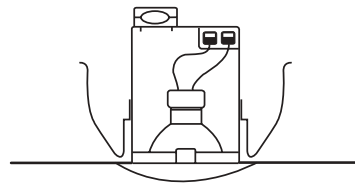

■ For ACTO showcases ceilings:

Fitted spotlight white, 220 volts, 40 watts.

N.B. all the spotlights are delivered complete with cable, EC plug, and light bulb.

# CASES

*Standard sizes :*

*D6, D5, D3, B6, C5 ( for 10 panels)*

*H6 and H5 for doors and big panels*

*S1 for 10 spotlights and accessories*

*AC for connectors and accessories*



Vertical cases made of 6 m/m "plywood", inserted into aluminium profile with protective angles, handles and locks. Inside rubber rails for panels partition.



The cases are specifically manufactured to resist all types of handling (sea,air,surface).

Optional wheels available.

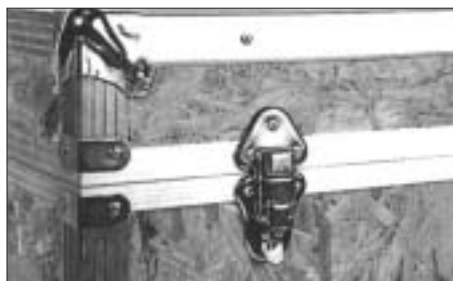
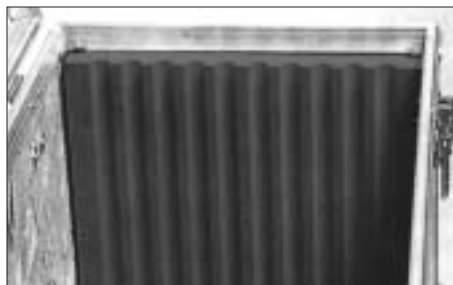

**Custom sizes manufacturing on request.**

## SETUP

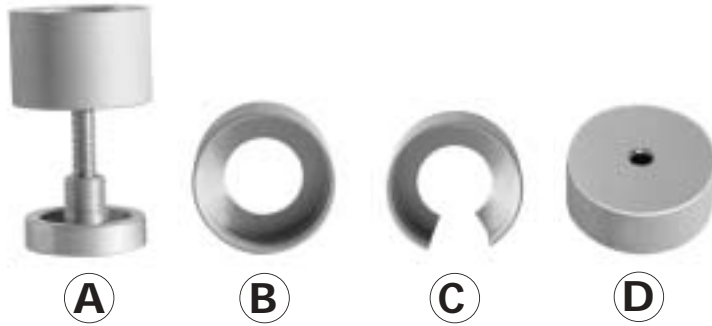

UP

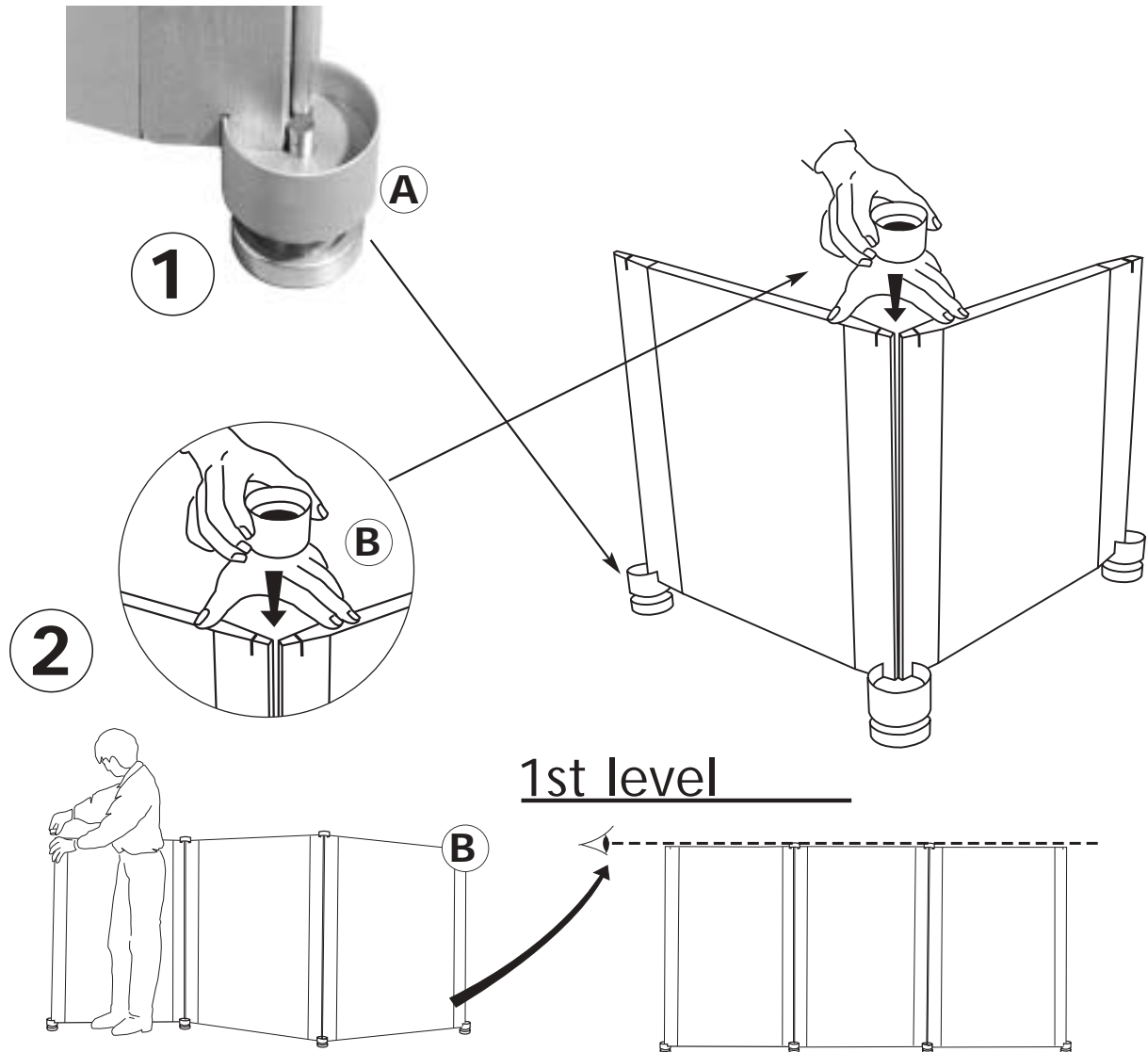

## SETUP

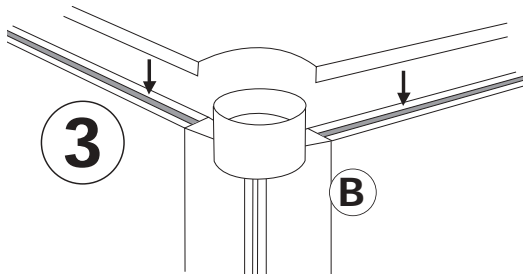

**5** 2nd level

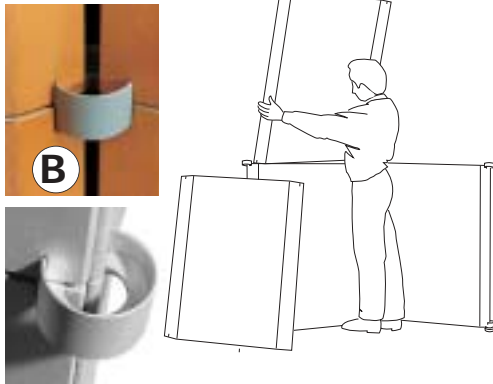

The door

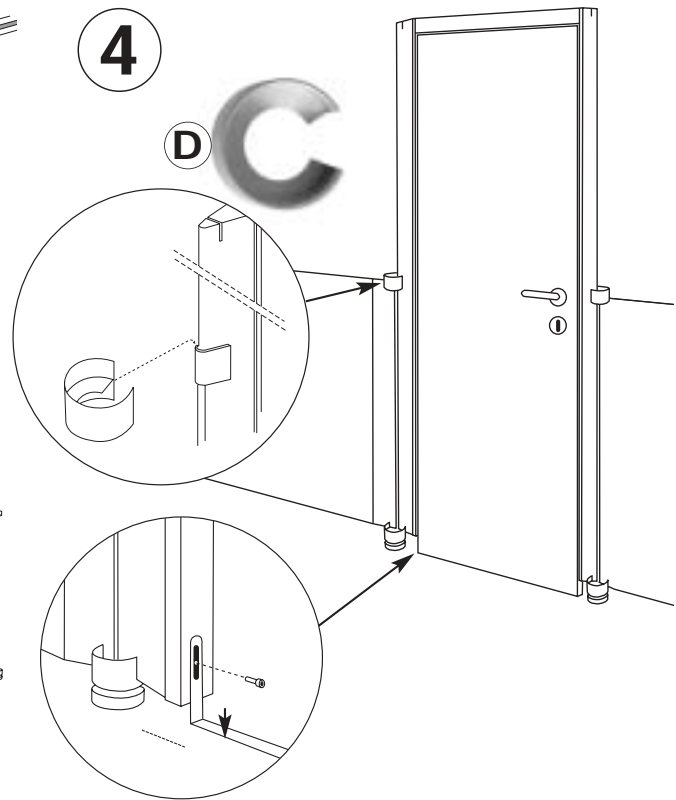

**6** Trusses

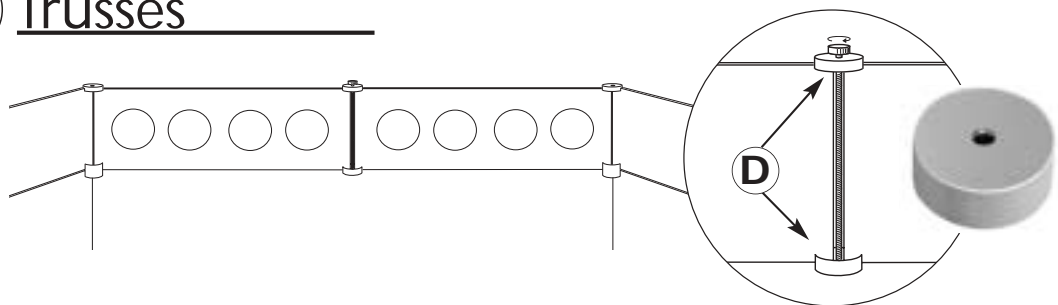

**7** The top

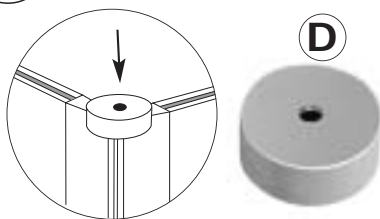

DOWN

